

Series A Specification



Explosion Proof

LED Flood Light



Model A2



Model A



Model A3



Explosion Protection

Marking Atex	II3 G Ex eb IIC T5/T6 Gb II2 D Ex op is tb IIIC T95°C/T80°C Db IP66
Marking IECEx	Ex eb IIC T5/T6 Gb Ex op is tb IIIC T95°C/T80°C Db IP66
Other Rating	IP 66

Applications

Oil and Gas industry

- ★ All petroleum production and refining
- ★ Petroleum loading and transportation
- ★ Petroleum storage and retail
- ★ LNG industry
- ★ All mining operations and service

Chemical industry

- ★ All types of painting facilities
- ★ Chemical production and storage

Ocean, marine and aerospace field

- ★ Ocean platform operation facilities and structure
- ★ Aerospace clean room and production
- ★ Ocean vessel operations

Metal treatment

- ★ Steel and aluminum factories
- ★ Pumping stations in any environment
- ★ Metal smelting, foundry and manufacturing

Food and alcohol industry

- ★ Flour and fine particle production and storage
- ★ Food and distilling production
- ★ Alcohol industry

Other high humidity, dust, high temperature, vapor locations

Materials

- ★ Housing: Die-casting aluminum
- ★ Diffuser: Tempered glass
- ★ Bolts: Stainless steel
- ★ Mounting Bracket: Stainless steel

Basic Data

Product Number	Wattage	CCT	Voltage Options	Lumens	Warranty	CRI	Emergency Time(Optional)
YB-20W A2YZDA	20	2700K-7000K	AC: 100-277V <input type="checkbox"/> AC: 200-480V <input type="checkbox"/> DC: 12-36V <input type="checkbox"/>	2800	5 years	70+	3 hours
YB-40W A2YZDA	40			5600			
YB-60W AYZDA	60			8400			
YB-80W AYZDA	80			11200			
YB-100W AYZDA	100			14000			
YB-120W A3YZDA	120			16800			
YB-150W A3YZDA	150			21000			
YB-200W A3YZDA	200			28000			

“A2, A, A3”=Product series; “Y”=D or N: Dimmable or non-dimmable; “Z”=CCT, from 2700K-7000K; “D”=Beam angle: 40°, 60°, 90°, 120°; A for glass info., blank for flat glass, C for spherical glass.

Series A Specification

Key Features

- High quality SMT LED and Meanwell Driver.
- Light-weight design by aircraft aluminum.
- Heavy-duty and high impact resistance.
- Three connection cable entry points.
- Replaceable LED board and drivers.
- Integrated junction box for driver.
- Dimmable and battery back up function available.
- Marine rating powder coated appearance treatment.
- Tempered glass resistant from high-energy impact.
- Stainless steel exposed fasteners.

Value-Added Features

- 10kv surge protection.
- Up to ten years limited warranty option.
- Emergency Battery back up(Option).
- Working temperature can be more than 85°C.
- Various installation ways for different applications.
- Glass lens or Glass with polycarbonate lens to make wider beam angle.
- Customized motion sensor(Option).
- Advanced smart system: WIFI & BLUE-TOOTH(Option).

Mechanical Structure

Unit: mm or inch

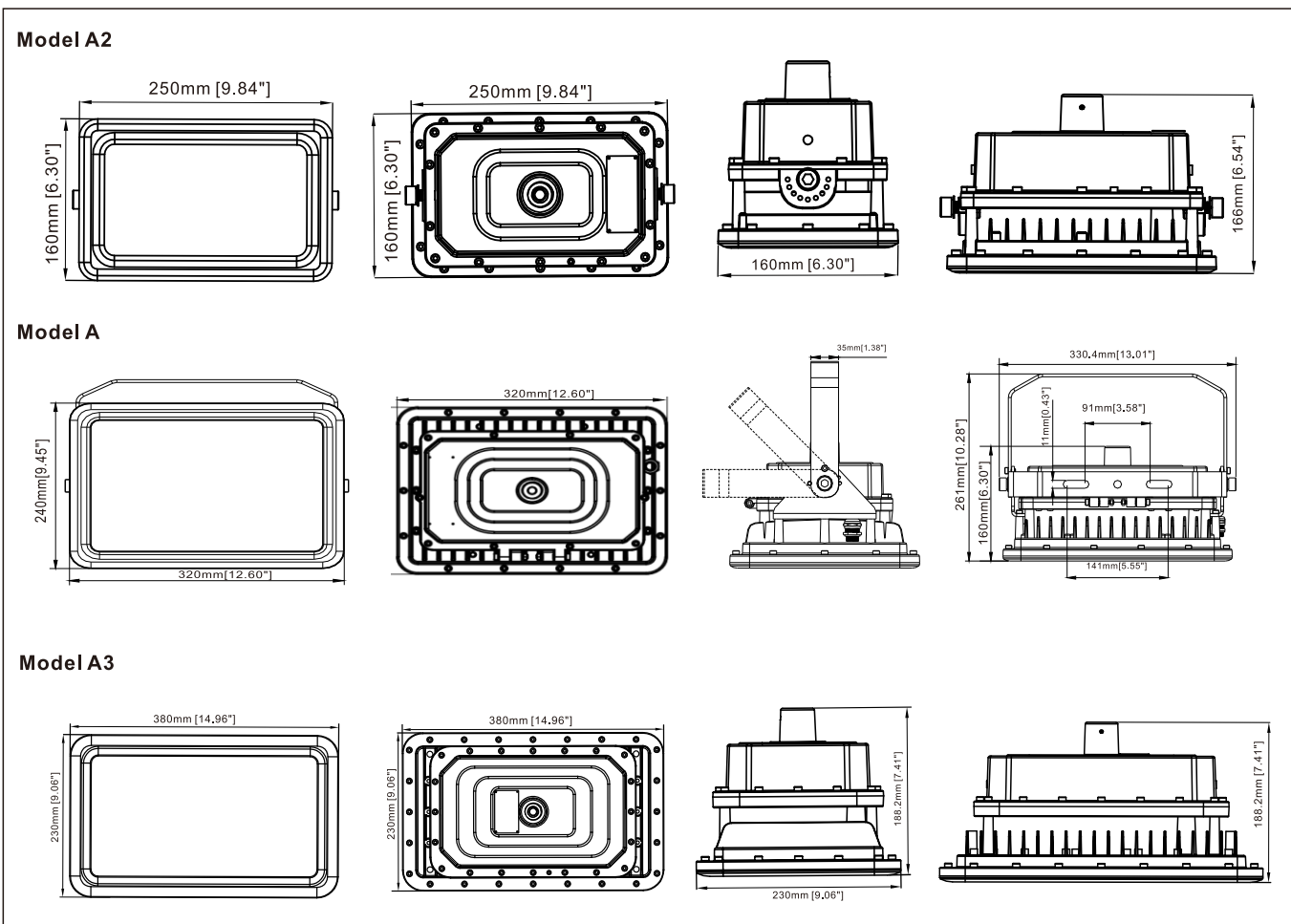

This structure type with bracket, flat glass and optical lens generates 40°, 60°, 90° and 120° light distribution.

Lighting Distribution

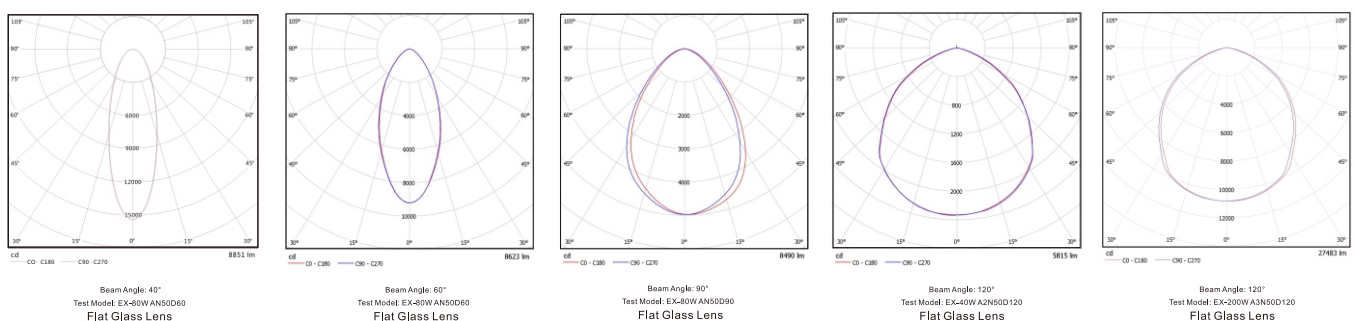

Series A Specification

Installation Manual

WARNING

READ INSTRUCTIONS CAREFULLY BEFORE INSTALLING. KEEP THIS INSTRUCTIONS FOR FUTURE REFERENCE. Fixtures must be wired in accordance with the National electrical code and all applicable local codes. Proper grounding is required for safety. THIS PRODUCT MUST BE INSTALLED IN ACCORDANCE WITH THE APPLICABLE INSTALLATION CODE BY QUALIFIED ELECTRICIAN WHO IS FAMILIAR WITH THE CONSTRUCTION AND OPERATION OF THE PRODUCT AND THE HAZARDOUS INVOLVED.

Warning: Risk of fire or electric shock. Flood light installation requires knowledge of luminaires and electrical systems. DO NOT open the enclosure when energized. DO NOT try to install if not qualified. Please contact a professional electrician.

Warning: Risk of fire or electric shock. Suitable for wet locations. Make sure the power is off prior to installation.

Warning: Risk of fire or electric shock. Suitable for non-insulated surface and frame. DO NOT cover fixture with insulation liner or similar material.

Warning: DO NOT install in unstable, loose or breakable surfaces.

Warning: DO NOT let objects impact or exert force on the surface of the fixture.

Ceiling Mounting



WARNING
Risk of fire, Electric shock or personal injury
Please turn off power before installation!

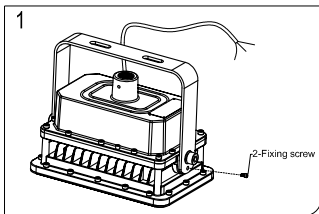

1. Install and tighten flexible metal conduit with the fixture.

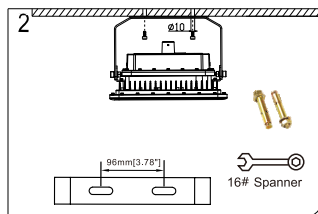

2. Drill 2x hole as shown in Fig.2, the distance can be 91~140mm. Then fixing $\phi 10$ expanded crews and bracket on ceiling.

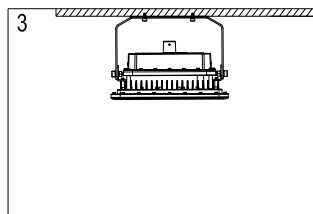

3. Connect black cable to L, white cable to N, green cable to grounding.

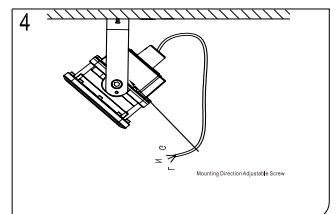

4. Adjust the beam angle from 0 to 180°.

Wall Mounting

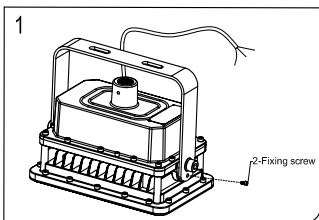

1. Take the fixture and accessory out from carton box, and tighten 2 fixing screws as Fig.1.

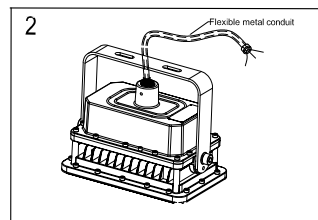

2. Install and tighten flexible metal conduit with the fixture.

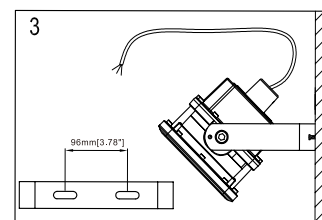

3. Drill 2x hole as Shown in Fig.2. The distance can be 91~140mm. Then fix $\phi 10$ expansion screws and bracket on ceiling.

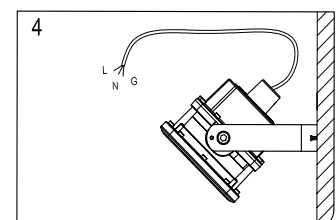

4. Connect black cable to L, white cable to N, and green cable to grounding.

Pole Mounting

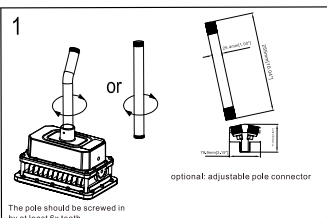

1. Take the fixture and pole accessory out from carton box, then tighten the pole as shown in Fig.1.

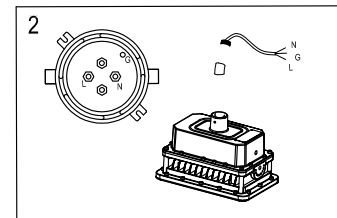

2. Connect black cable to L, white cable to N, and green cable to grounding.

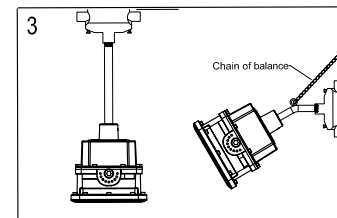

3. Drill 4x $\phi 10$ mm holes separated by 100mm, install the junction box to the wall or ceiling as shown in Fig.3, tighten the pole to the box, and then adjust the chain of balance.

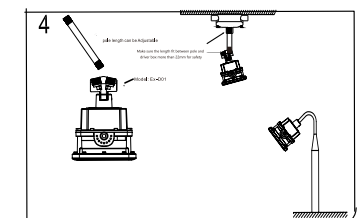

4. Adjustable pole installation. With this adjustable kit, you can make any light distribution direct as you want. Optional: Install the fixture to the long pole after connecting the cable.

Series A Specification

Hook Pendant

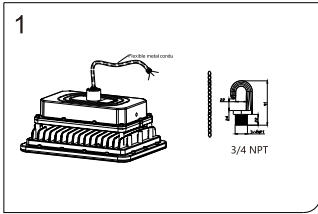

1. Take the fixture and accessory out from carton box, and tighten 2x angle holder screws as shown in Fig.1.

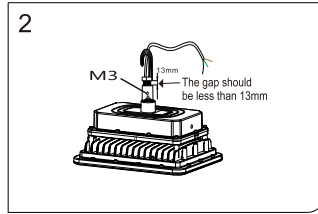

2. Tighten the hook with the fixture, at least 6x teeth need to be screwed in. Fix the M3 screw to prevent the hook from loosening.

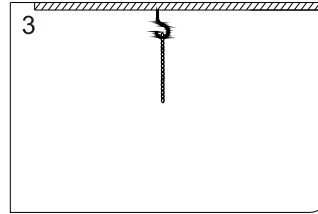

3. Drill 1 expansion screw hole and install it, and hang the chain as shown in Fig.3.

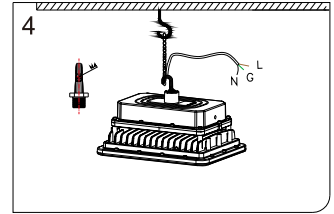

4. Hang the fixture to the hook as above. Connect black cable to L, white cable to N, and green cable to grounding.

Arm Mounting

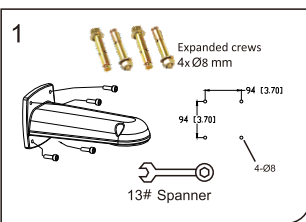

1. Drill 4x holes as above distance. Fix the arm on the wall, and tighten 4x screws as shown in Fig.1.

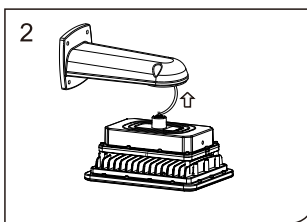

2. Connect the power AC wire with lamp, and put the terminal into the arm.

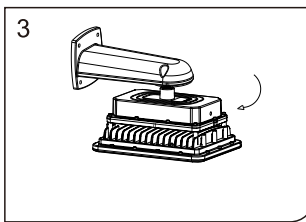

3. Match the circle part with arm, and rotate it to right.

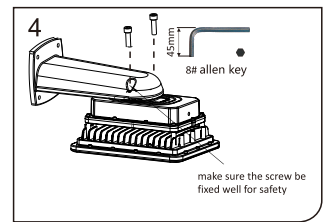

4. Tighten 2x screws to avoid the lamp to loosen.

- This installation method is only for Model A2 and Model A. It can not be applied on model A3 because model A3 is too heavy.
- Only one electrician is required for this installation.

Stanchion Mounting

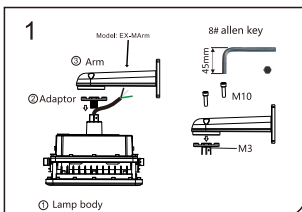

1. Tighten part 2 and assemble 1, and fix the M3 screw. Install the arm to the adaptor, and tighten the M10 via 8# allen key.

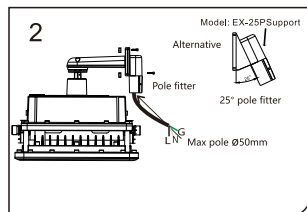

2. Install the pole fitter with arm via 4x M8 screws (The max suitable pole diameter is 50mm). The 25 degree pole fitter could be an alternative.

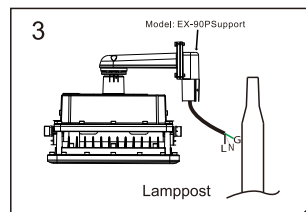

3. Connect the cable to AC wire, black cable to L, white cable to N, and green cable to grounding.

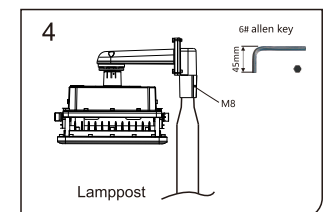

4. Slip the fitter to the lamppost and tighten with M8 inner hexagonal screw.

- This installation method is only for Model A2 and Model A. It can not be applied on model A3 because model A3 is too heavy.
- Only one electrician is required for this installation.

Wall Mounting to junction box

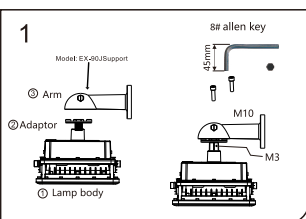

1. Tighten part 2 and assemble 1, and fix the M3 screw. Install the arm to the adaptor, and tighten the M10 via 8# allen key.

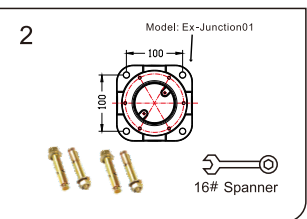

2. Drill 4x φ10mm holes and install the junction box to the wall with M10 expanded screw.

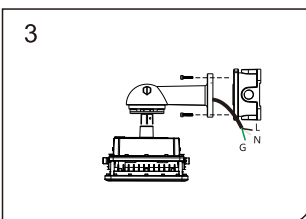

3. Connect the AC wire to power system. Connect black cable to L, white cable to N, and green cable to grounding.

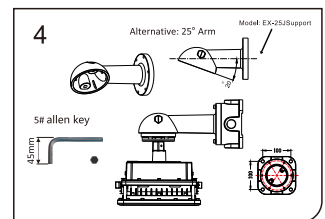

4. Tighten 6 x screws between arm and junction box. Turn on the power and test the lumination.

Series A Specification

Packing Information

Model	Quantity/Ctn	Length(cm)	Width(cm)	Height(cm)	Net weight(kg)	Gross weight (kg)
A2	1	36.5	27	30.5	4.15	5.3
A	1	37.5	34	21.5	6.95	7.9
A3	1	48.5	34	36.5	8.3	10.3

Accessories



- Model: YB-Junction01
Name: Junction Box
Material: Aircraft Aluminum A383



- Model: YB-Hook
Name: Installation Hook
Material: Aircraft Aluminum A383



- Model: YB-Conduit01
Name: Metal Conduit
Material: Stainless Steel and Aluminum



- Model: YB-WPipe
Name: Winding Swing Pipe
Material: Iron with Power Coating



- Model: YB-SPipe
Name: Winding Swing Pipe
Material: Iron with Power Coating



- Model: YB-D01
Name: Pendant Direction Adapter
Material: Aircraft Aluminum A383



- Model: YB-MArm
Name: Surface Mounting Arm
Material: Aircraft Aluminum A383



- Model: YB-25PSupport
Name: 25 Degree Pole Support
Material: Aircraft Aluminum A383



- Model: YB-90PSupport
Name: 90 Degree Pole Support
Material: Aircraft Aluminum A383



- Model: YB-90JSupport
Name: 90° Arm to Junction box
Material: Aircraft Aluminum A383



- Model: YB-25JSupport
Name: 25° Arm to Junction box
Material: Aircraft Aluminum A383



- Model: YB-DArm
Name: Direct Mounting Arm
Material: Aircraft Aluminum A383



- Model: YB-PCH
Name: Pendant Chain
Material: Stainless Steel S30400