

# Series I Specification

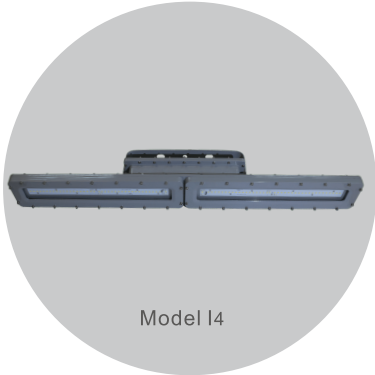

## Explosion Proof

### LED Linear light



### Materials

- ★ Housing: Die-casting aluminum
- ★ Diffuser: Tempered glass
- ★ Bolts: Stainless steel
- ★ Mounting Bracket: Stainless steel

### Explosion Protection

Marking UL844 (North American)	Class I, Division 1, Groups C, D Class I, Division 2, Groups A, B, C, D Class II, Division 1, Groups E, F, G Class II, Division 2, Groups F, G Class III
Marking Marine	UL 1598A
Other Rating	IP 66

### Applications

#### Oil and Gas industry

- ★ All petroleum production and refining
- ★ Petroleum loading and transportation
- ★ Petroleum storage and retail
- ★ LNG industry
- ★ All mining operations and service

#### Chemical industry

- ★ All types of painting facilities
- ★ Chemical production and storage

#### Ocean, marine and aerospace field

- ★ Ocean platform operation facilities and structure
- ★ Aerospace clean room and production
- ★ Ocean vessel operations

#### Metal treatment

- ★ Steel and aluminum factories
- ★ Pumping stations in any environment
- ★ Metal smelting, foundry and manufacturing

#### Food and alcohol industry

- ★ Flour and fine particle production and storage
- ★ Food and distilling production
- ★ Alcohol industry

Other high humidity, dust, high temperature, vapor locations

### Basic Data

Part Number	Wattage	CCT	Voltage Options	Lumens	Warranty	CRI	Emergency Time (Option)
YB-20W I2YZDA	20	2700K-7000K	AC: 100-277V <input type="checkbox"/> AC: 200-480V <input type="checkbox"/> DC: 12-36V <input type="checkbox"/>	2800	5 years	70+	3 hours
YB-40W I2YZDA	40			5600			
YB-60W I2YZDA	60			8400			
YB-60W I4YZDA	60			8400			
YB-80W I4YZDA	80			11200			
YB-100W I4YZDA	100			14000			
YB-120W I4YZDA	120			16800			

"I2, I4"=Product code; "Y"=D or N: Dimmable or Non-dimmable; "Z"=CCT, from 2700~7000K; "D"=Beam angle, D40 for 40°, D60 for 60°, D90 for 90°, D120 for 120°; A for glass info., blank for flat glass, C for spherical glass.

# Series I Specification

## Key Features

- High quality SMT LED and Meanwell Driver.
- Light-weight design by aircraft aluminum.
- Heavy-duty and high impact resistance.
- Three connection cable entry points.
- Replaceable LED board and drivers.
- Integrated junction box for driver.
- Dimmable and battery back up function available.
- Marine rating powder coated appearance treatment.
- Adjustable mounting bracket(0-180 degree).

## Value-Added Features

- 10kv surge protection.
- Up to ten years limited warranty option.
- Emergency Battery back up(Optional) .
- Working temperature can be more than 85°C.
- Various installation ways for different applications.
- Glass lens or Glass with polycarbonate lens to make wider beam angle.
- Customized motion sensor(Optional) .
- Advanced smart system: WIFI & BLUE-TOOTH(Optional).

## Mechanical Structure

Unit: mm or inch

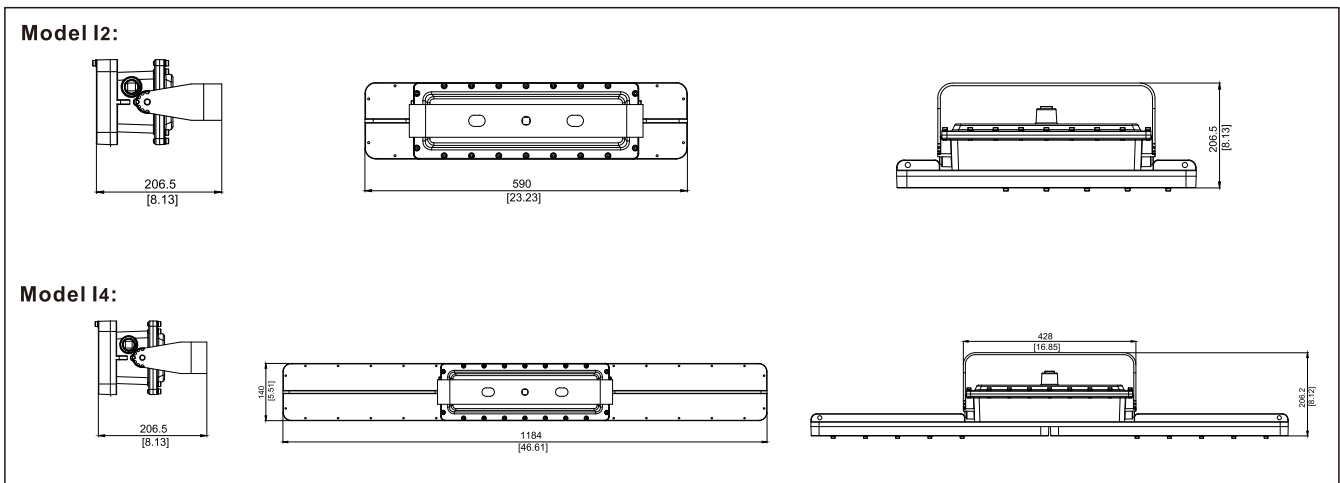

## Lighting Distribution

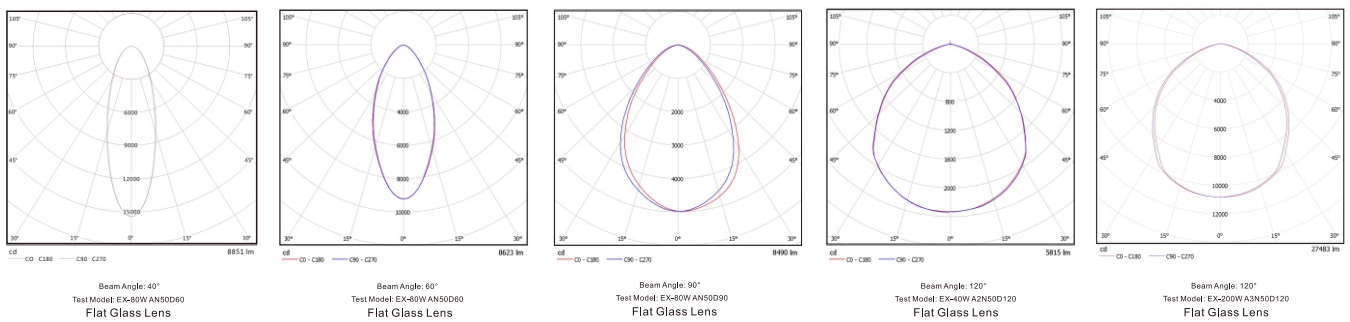

## Installation Manual

READ INSTRUCTIONS CAREFULLY BEFORE INSTALLATION. KEEP THE INSTRUCTIONS FOR FUTURE REFERENCE. Fixtures must be wired in accordance with the National electrical code and all applicable local codes. Proper grounding is required for safety.

THIS PRODUCT MUST BE INSTALLED IN ACCORDANCE WITH THE APPLICABLE INSTALLATION CODE BY QUALIFIED ELECTRICIAN WHO IS FAMILIAR WITH THE CONSTRUCTION AND OPERATION OF THE PRODUCT AND THE HAZARDOUS INVOLVED.

**Warning:** Risk of fire or electric shock. Linear light installation requires knowledge of luminaires and electrical systems. DO NOT open the enclosure when energized. DO NOT try to install if not qualified. Please contact a professional electrician.

**Warning:** Risk of fire or electric shock. Suitable for wet locations. Make sure the power is off prior to installation.

**Warning:** Risk of fire or electric shock. Suitable for non-insulated surface and frame. DO NOT cover fixture with insulation liner or similar material.

**Warning:** DO NOT install in unstable, loose or breakable surfaces.

**Warning:** DO NOT let objects impact or exert force on the surface of the fixture.

# Series I Specification

## Chain Mounting



**⚠ WARNING**  
Risk of fire, Electric shock or personal injury  
Please turn off power before installation!

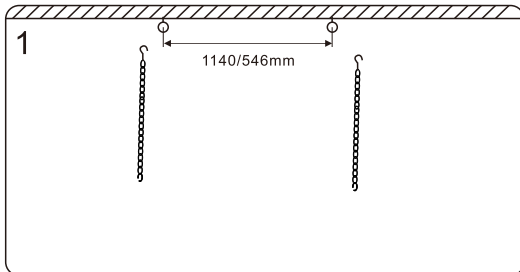

1. Drill 2x hole for hanging ring(1140mm for 4FT fixture or 546mm for 2FT fixture), and fixing them.

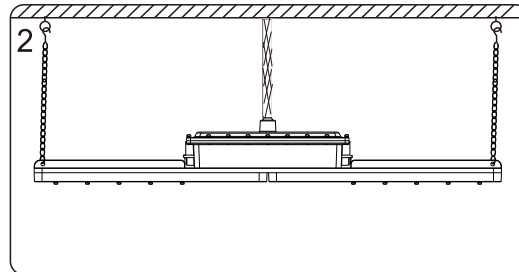

2. Fix the hanging chain to light fixture. Wire the cable through the metal conduit and then connect it with the power.

## Pole Mounting

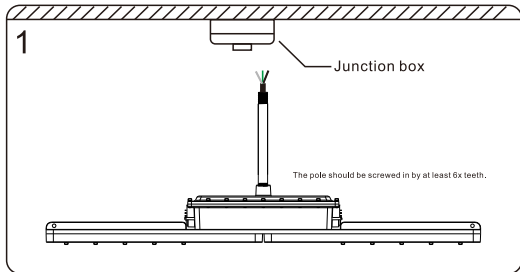

1. Wire the cable through the pole and then install the pole to the fixture.

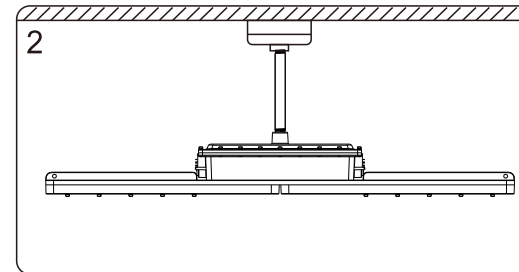

2. Wire the cable to enclosure of junction box and install the pole to junction box.

## Bracket Mounting

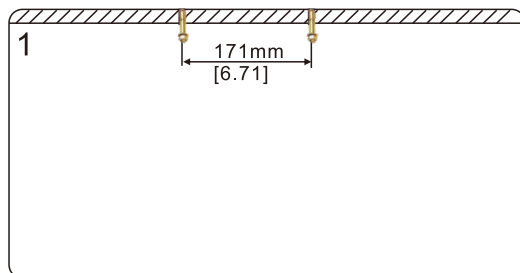

1. Drill 2x  $\varnothing 15$  holes for expanded screws, and fix them to the ceiling.

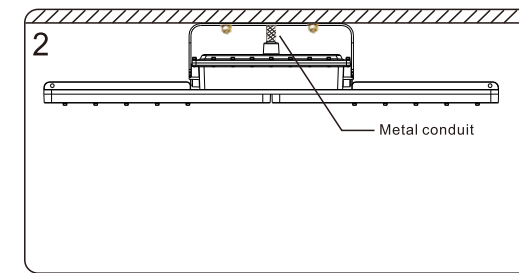

2. Install the fixture to the expanded screws, and tighten the nuts. (Metal conduit needs to be applied here)

## Pole Bracket Mounting

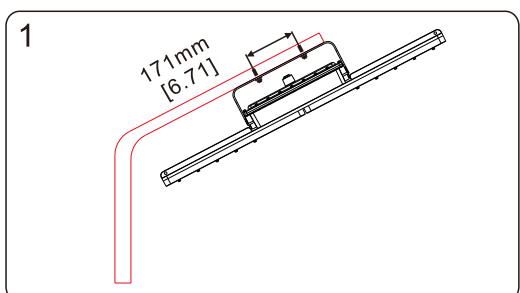

1. Drill 2x  $\varnothing 15$  holes for fixing screws.

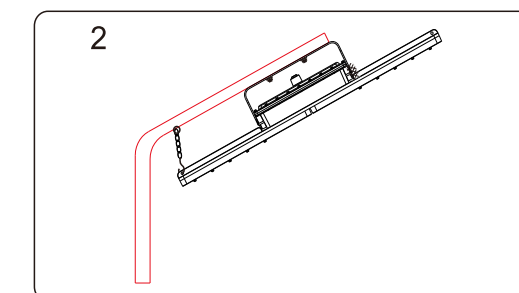

2. Fix the pendant chain and hook the fixture. Insert 2x  $\varnothing 15$  fixing screws and weld them on the pole bracket with the fixture.

# Series I Specification

## Wall Mounting



1. Drill 2x  $\varnothing$ 15 hole for expanded screws, and fix them to the wall. (Horizontal distance: 171mm)

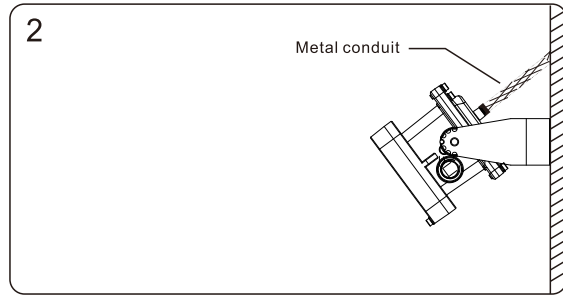

2. Install the fixture to wall and connect the wire to AC power. (Metal conduit needs to be applied here)

## Packing Information

Model	Quantity/Ctn	Length(cm)	Width (cm)	Height(cm)	Net weight(kg)	Gross weight (kg)
I2	1	77	34	26.5	12	14
I4	1	136	34	26.5	18.5	21.5

## Accessories



- Model: YB-Junction01  
Name: Junction Box  
Material: Aircraft Aluminum A383



- Model: YB-Hook  
Name: Installation Hook  
Material: Aircraft Aluminum A383



- Model: YB-Conduit01  
Name: Metal Conduit  
Material: Stainless Steel and Aluminum



- Model: YB-WPipe  
Name: Winding Swing Pipe  
Material: Iron with Power Coating



- Model: YB-SPipe  
Name: Winding Swing Pipe  
Material: Iron with Power Coating



- Model: YB-D01  
Name: Pendant Direction Adapter  
Material: Aircraft Aluminum A383



- Model: YB-PCH  
Name: Pendant Chain  
Material: Stainless Steel S30400