

LED FLOOD LIGHT(EGL08)



DESCRIPTION

The MFD08 luminaire is a high performance LED lighting solution designed with optical versatility and a slim, low profile design. Its rugged cast aluminum housing minimizes wind load requirements and features an integral, watertight LED driver compartment and high performance aluminum heat sinks. Markets include parking lots, walkways, campuses, car dealerships, office complexes, and internal roadways.

SPECIFICATION FEATURES

Construction

- Housing, electrical compartment and fitter are all made from die case aluminum that is pre-treated and powder-coated to meet the most rugged industry standards.
- Door frame features an integral accessory channel for the mounting of optional light control accessories.
- Vented housing isolates LED module from driver, maximizing product life and performance
- Door frame seals to housing with a continuous extruded silicone gasket.

Optics

- Optics(NEMA Type): 7H*6V, 4Hx4V
- Scalable Lumen Packages from 1,950 to 50,000 Lumens.
- Provides the best combination of vertical and horizontal illumination while reducing light behind the poles.
- High performance acrylic optic securely attached to internal heat sink for maximum thermal dissipation.

Electrical

- Universal 120-277 VAC or 347-480 VAC input voltage.
- Both drivers have a power factor >90%, THD <20%, and an expected life of 100,000 hours.
- Operating Temperature Range: -40°C - + 40°C (-40°F - + 104°F)

Lifespan

- Estimated 100,000-hour LED lifespan based on IES LM-80 results and TM-21 calculations

Warranty

- Five-year warranty.

Certifications

- DesignLights Consortium™ Qualified.
- UL cUL wet location listed.
- Note: DesignLights Consortium™ Qualified and classified for DLC Standard (all lumen packages), refer to www.designlights.org for details.

15W&27W



70W&100W



135W&200W



350W



45W&60W



PHOTOMETRICS

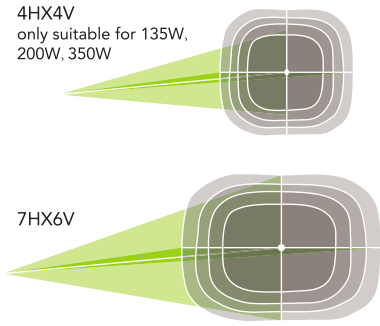

ACCESSORIES



Photocell

No. PC-JL-120-277V

USE: Photocell is field installed or pre-installed in factory by requesting

DIMENSIONS

unit: mm/inch

15W&27W(Knuckle Mount)

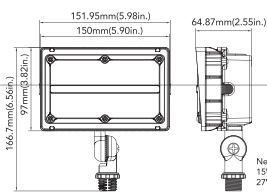

15W&27W(Trunnion Mount)

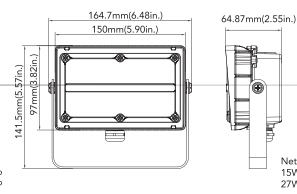

45W&60W(Knuckle Mount)

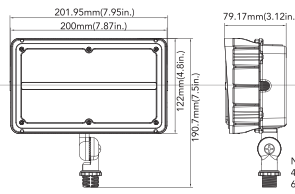

45W&60W(Trunnion Mount)

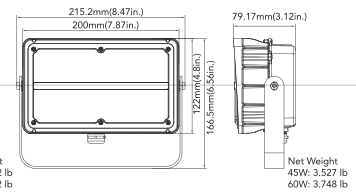

70W&100W(Slipfitter Mount)

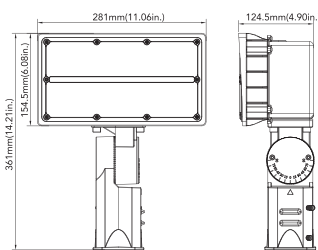

70W&100W(Yoke Mount)

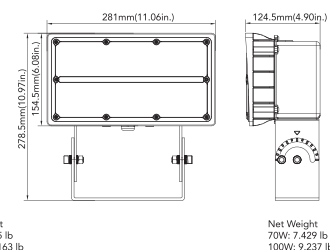

135W&200W(Slipfitter Mount)

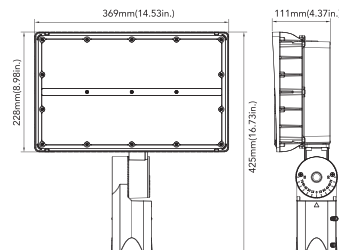

135W&200W(Yoke Mount)

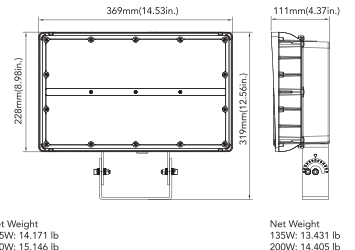

350W(Trunnion Mount)

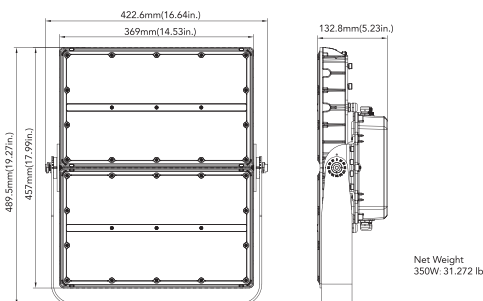





PERFORMANCE DATA

SYSTEM WATTS	VOLTAGE	DIST.TYPE	CRI	LUMENS (3000K)	LPW (3000K)	LUMENS (4000K)	LPW (4000K)	LUMENS (5000K)	LPW (5000K)
15W	120-277V	7Hx6V	70	1950lm	130 lm/W	2000lm	133 lm/W	2000lm	133 lm/W
27W	120-277V	7Hx6V	70	3500lm	130 lm/W	3600lm	133 lm/W	3600lm	133 lm/W
45W	120-277V	7Hx6V	70	5550lm	123 lm/W	5650lm	126 lm/W	5650lm	126 lm/W
60W	120-277V	7Hx6V	70	7250lm	121 lm/W	7450lm	124 lm/W	7450lm	124 lm/W
60W	347-480V	7Hx6V	70	7500lm	125 lm/W	7600lm	127 lm/W	7600lm	127 lm/W
70W	120-277V	7Hx6V	70	8700lm	124 lm/W	8900lm	127 lm/W	8900lm	127 lm/W
70W	347-480V	7Hx6V	70	9100lm	130 lm/W	9300lm	133 lm/W	9300lm	133 lm/W
90W	347-480V	7Hx6V	70	12000lm	133 lm/W	12400lm	138 lm/W	12400lm	138 lm/W
100W	120-277V	7Hx6V	70	13100lm	131 lm/W	13300lm	133 lm/W	13300lm	133 lm/W
135W	120-277V	4Hx4V	70	17500lm	130 lm/W	18000lm	133 lm/W	18000lm	133 lm/W
135W	347-480V	4Hx4V	70	17500lm	130 lm/W	18000lm	133 lm/W	18000lm	133 lm/W
135W	120-277V	7Hx6V	70	17500lm	130 lm/W	18000lm	133 lm/W	18000lm	133 lm/W
135W	347-480V	7Hx6V	70	17500lm	130 lm/W	18000lm	133 lm/W	18000lm	133 lm/W
200W	120-277V	4Hx4V	70	26000lm	130 lm/W	26500lm	133 lm/W	26500lm	133 lm/W
200W	347-480V	4Hx4V	70	26000lm	130 lm/W	26500lm	133 lm/W	26500lm	133 lm/W
200W	120-277V	7Hx6V	70	25300lm	127 lm/W	26200lm	131 lm/W	26200lm	131 lm/W
200W	347-480V	7Hx6V	70	25300lm	127 lm/W	26200lm	131 lm/W	26200lm	131 lm/W
350W	120-277V	4Hx4V	70	48000lm	137 lm/W	49500lm	141 lm/W	49500lm	141 lm/W
350W	347-480V	4Hx4V	70	48000lm	137 lm/W	49500lm	141 lm/W	49500lm	141 lm/W
350W	120-277V	7Hx6V	70	48000lm	137 lm/W	50000lm	143 lm/W	50000lm	143 lm/W
350W	347-480V	7Hx6V	70	48000lm	137 lm/W	50000lm	143 lm/W	50000lm	143 lm/W

ELECTRICAL DATA

Number Of Drivers	Driver Current (mA)	Nominal Power (W)	INPUT VOLTAGE (V)	CURRENT (Amps)
1	250	15	120	0.13
		15	208	0.07
		15	240	0.06
		15	277	0.05
1	430	27	120	0.23
		27	208	0.13
		27	240	0.11
1	770	45	277	0.10
		45	120	0.38
		45	208	0.22
1	920	45	240	0.19
		45	277	0.16
		60	120	0.50
1	1600	60	208	0.29
		60	240	0.25
		60	277	0.22
1	1750	60	347	0.17
		60	480	0.13
		70	120	0.58
1	1850	70	208	0.34
		70	240	0.29
		70	277	0.25
1	2600	70	347	0.20
		70	480	0.15
		100	120	0.83
1	2400	100	208	0.48
		100	240	0.42
		100	277	0.36
2	3500	90	347	0.26
		90	480	0.19
		135	120	1.13
		135	208	0.65
		135	240	0.56
2	5000	135	277	0.49
		135	347	0.39
		135	480	0.28
		200	120	1.67
		200	208	0.96
1	5600	200	240	0.83
		200	277	0.72
		200	347	0.58
		200	480	0.42
		350	120	2.92
1	5600	350	208	1.68
		350	240	1.46
		350	277	1.26
		350	347	1.01
		350	480	0.73

EPA

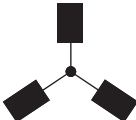
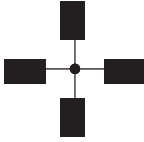
Item							
	1	2 @90°	2 @120°	2@180°	3 @90°	3 @120°	4 @90°
70W/100W	0.2885	0.6097	0.7475	0.577	0.8982	0.8196	0.8982
135W/200W	0.3868	0.8125	0.9973	0.7736	1.1993	1.0874	1.1993
350W	0.536	1.061	1.278	1.072	1.597	1.803	1.597

ORDERING GUIDE

Example: E GL0845W27V50KYYYYY

Fixture Type <input type="text"/>	Wattage <input type="text"/>	Voltage <input type="text"/>	CCT <input type="text"/>	Dimmable <input type="text"/>	Finish <input type="text"/>	Photocell (Option) <input type="text"/>	Nema <input type="text"/>	Mounting <input type="text"/>	Internal Code <input type="text"/>
EGL08 Flood Light series	15 15W 27 27W 45 45W 60 60W 70 70W 90 90W 100 100W 135 135W 200 200W 350 350W	27V 120-277V 48V 347-480V	30K 3000K 40K 4000K 50K 5000K	D 1-10VDIM Blank NO DIM	D Dark Bronze B Black W White	P0 With Photocell Blank Without Photocell	B44 4HX4V B76 7HX6V	TR Trunion Mount KN Knuckle Mount YK Yoke SP Slipfitter Mount	Blank Alphanumeric

- Note: 1. 15W,27W,45W,60W only suitable for non dimming.
 2. 70W with dimming and non dimming options.
 3. 90W,100W,135W,200W,350W only suitable for dimming.
 4. Only 60W,70W,90W,135W,200W,350W suitable for 347-480V input valtage.
 5. Only 135W,200W,350W optional for NEMA 4Hx4V

MOUNTING

1/2" Knuckle Mount (15W/27W/45W/60W)



Trunion Mount (15W/27W/45W/60W/350W)



Yoke Mount (70W/100W/135W/200W)



Slipfitter Mount (70W/100W/135W/200W)

